



Operation Manual

Inclinometers
IN61 / IN71



Table of Contents

1	Document	4
2	General Information	5
2.1	Target Group.....	5
2.2	Symbols used / Classification of the Warnings and Safety instructions	5
2.3	Preliminary Remark	6
2.4	Feedback	6
2.5	Transport / Storage	6
2.6	Use According to the Intended Purpose	6
2.7	Foreseeable Misuse.....	6
2.8	Other Applicable Documents	7
3	Product Description	8
3.1	Function of an Inclinator.....	8
3.2	Devices Overview	9
3.2.1	LED Display Elements	10
3.3	Technical Data	10
3.3.1	General	10
3.3.2	Product conformity	11
4	Installation	12
4.1	Mechanical Installation.....	12
4.1.1	General Information for the Mounting of Inclinator.....	12
4.1.2	Mounting Instructions for Inclinator	12
4.1.3	Cable routing	13
4.1.4	Step-by-Step Installation.....	13
4.2	Electrical Installation	14
4.2.1	General Information for the Connection.....	14
4.2.2	Information for EMC-Compliant Installation	14
4.2.3	Connecting the Connecting Wires	15
4.2.4	Sensor Terminal Assignment.....	16
5	Commissioning and Operation	17
5.1	Functions and Operating Modes.....	17
5.1.1	Setting Possibilities.....	17
5.1.2	Analog Outputs	17
5.1.3	Measuring axes	18
5.2	Status LED.....	18
5.3	Commissioning	19
5.3.1	Commissioning Help - Spirit Level.....	19
5.4	Parameterizing.....	19
5.4.1	Manual Parameterizing via Easy-Teach	20
5.4.2	Software-Aided Parameterizing	22
5.4.3	Filters	24

6	Maintenance	27
6.1	Eliminating disturbances	27
6.2	Disassembly.....	27
6.3	Reassembly	27
7	Disposal	28
8	Annex	29
8.1	Decimal / Hexadecimal conversion table.....	29
8.2	Conversion table Data types.....	30
9	Contact.....	31
	Glossary.....	32

1 Document

This is the English translation of the original operation manual in German language.

Publisher	Kübler Group, Fritz Kübler GmbH Schubertstraße 47 78054 Villingen-Schwenningen Germany www.kuebler.com
Issue date	03/2024
Copyright	© 2024, Kübler Group, Fritz Kübler GmbH

Legal Notices

All of the contents of this document are protected by the rights of use and copyrights of Fritz Kübler GmbH. Any duplication, modification, further use and publications in other electronic or printed media, as well as their publication in the Internet, even partially, is subject to the previous written authorization by Fritz Kübler GmbH.

The brand names and product brands mentioned in this document are trademarks or registered trademarks of the respective titleholders.

Subject to errors and changes. The stated product features and technical data shall not constitute any guarantee declaration.

2 General Information



Please read this document carefully before working with the product, mounting it or starting it up.



These operating instructions guide the technical personnel of the machine and plant manufacturer or operator for safe assembly, installation, commissioning and operation of the product.

2.1 Target Group

The device may only be planned, mounted, commissioned and serviced by persons having the following qualifications and fulfilling the following conditions:

- Technical training.
- Briefing in the relevant safety guidelines.
- Constant access to this documentation.

2.2 Symbols used / Classification of the Warnings and Safety instructions

 DANGER	<p>Classification:</p> <p>This symbol, together with the signal word DANGER, warns against immediately imminent threat to life and health of persons.</p> <p>The non-compliance with this safety instruction will lead to death or severe adverse health effects.</p>
 WARNING	<p>Classification:</p> <p>This symbol, together with the signal word WARNING, warns against a potential danger to life and health of persons.</p> <p>The non-compliance with this safety instruction may lead to death or severe adverse health effects.</p>
 CAUTION	<p>Classification:</p> <p>This symbol, together with the signal word CAUTION, warns against a potential danger for the health of persons.</p> <p>The non-compliance with this safety instruction may lead to slight or minor adverse health effects.</p>
ATTENTION	<p>Classification:</p> <p>The non-compliance with the ATTENTION note may lead to material damage.</p>

NOTICE	Classification:
	Additional information relating to the operation of the product, and hints and recommendations for efficient and trouble-free operation.

2.3 Preliminary Remark

The following basic safety instructions are intended to avoid personal injuries and damage to property; they relate primarily to the use of the products described herein. If you additionally use further components, also consider their warnings and safety instructions.

2.4 Feedback

We endeavor to make these instructions as informative and clear as possible. If you have any suggestions or are missing information in the instructions, please send your feedback to: support@kuebler.com.

2.5 Transport / Storage

Check the delivery immediately upon receipt for possible transport damages. If you do not mount the device immediately, store it preferably in its transport package.

The device must be stored at a dry and dust-free location, in compliance with the technical data, see chapter Technical Data [▶ 10].

2.6 Use According to the Intended Purpose

The inclinometer can be used as a measuring system for the acquisition of the inclination or rotation angle.

The device may only be operated as described in these instructions. Any other use is considered as non compliant with the intended use.

The measuring system and its evaluation unit must meet the requirements mentioned in chapter Technical Data [▶ 10].

2.7 Foreseeable Misuse

The inclinometer is not suitable for the following uses:

- Under water.
- In publicly accessible areas.
- Outside the product specification.
- These devices are not safety components; they may not be used for personal or property protection.

2.8 Other Applicable Documents

NOTICE	Technical Data
	All technical data, as well as the mechanical and electrical characteristics, are specified in the data sheets of the corresponding device variant, for special versions in the corresponding quotation / customer drawing of the product.

All documents such as the original declarations of conformity or the relevant certificates can be downloaded from our homepage:

www.kuebler.com/de/docu-finder

3 Product Description

3.1 Function of an Inclinometer

An inclinometer is a measuring device intended for the acquisition of the inclination angle. The sensor establishes an exact reference to the vertical direction. The gravity of earth is used as the reference. Any angular change is detected by the measuring cell. The measured angle is converted into electrical signals and output in various formats.

Static Inclinometers (IN6x)

The inclinometers use an acceleration measuring cell (MEMS) to determine the angle and output this angle according to the measuring axis or axes.

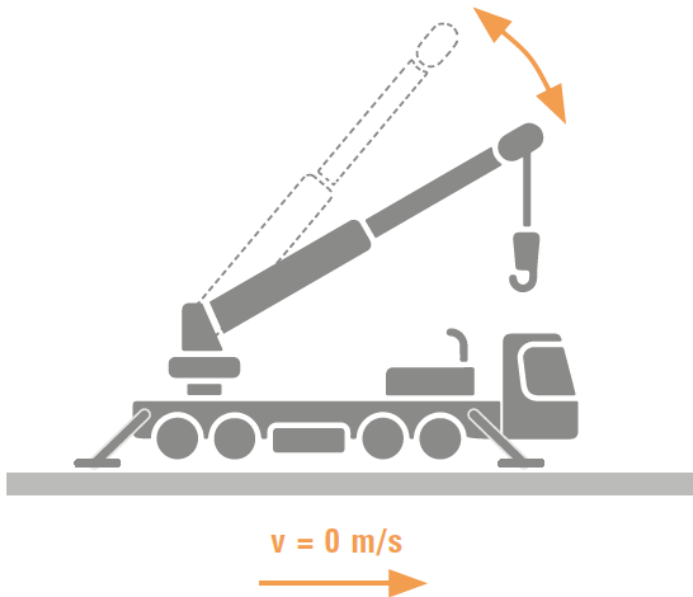

IMG-ID: 340644107

The signal is processed and linearized. Integrated filters may be used for smoothing, so as to output an angle.

In many static applications (such as e.g. solar panels, crane masts...) a pure filter function is sufficient, since a time delay of the signal is not relevant. However, in dynamic applications (e.g. vehicles in motion), this can lead to problems, as a reaction to the movement can only occur with a delay. It is then advisable to use a dynamic inclinometer with intelligent sensor fusion from Kübler, for further optimization of the measurement result.

Dynamic Inclinometers (IN7x)

The dynamic inclinometers use an acceleration measuring cell (MEMS) and a rotary rate measuring cell (gyroscope) to determine the angle.

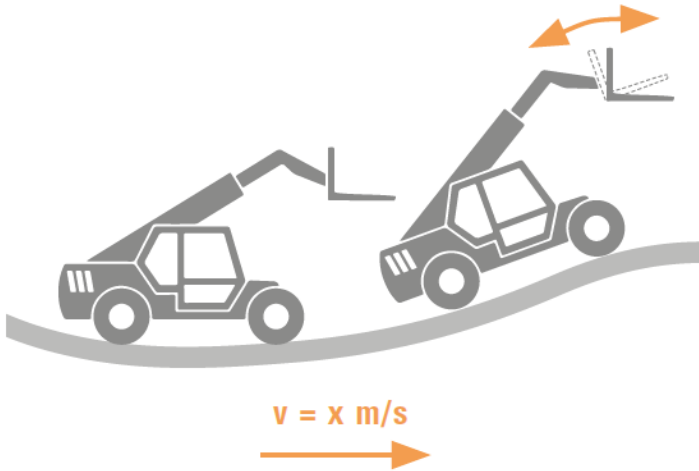

IMG-ID: 340645771

These devices output the angles according to the measuring axis or to the measuring axes. A fusion algorithm uses the acceleration values and the rotary rates to calculate the inclination angle. The filters minimize the influence of vibrations and other interferences, the fusion algorithm optimizes the speed and the accuracy of the output signal. Therefore, the sensor can output a stable signal even in dynamic applications.

3.2 Devices Overview

The inclinometers IN6x / IN7x are equipped with an M12 connector for connecting the sensor cable. The housing is made of plastic and is entirely encapsulated.

- Angle acquisition
 - 1-axis devices: 0...360°, resolution 16 bits
 - 2-axes devices: ±85°, resolution 16 bits
- High protection level: IP68 / IP69K
- The functions of the device can be set by means of an FDT framework (e.g. PACTware).
- The devices have an additional Easy-Teach function.
- The devices have a spirit level function.

The dynamic inclinometers IN7x have in addition the following features:

- Gyroscope sensor

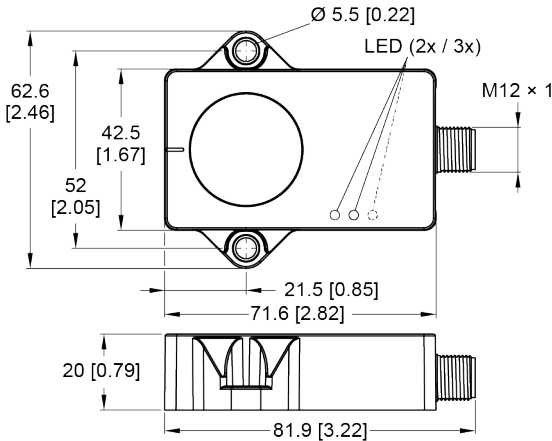

IMG-ID: 334234123

3.2.1 LED Display Elements

The 1-axis devices have a green and a yellow LED.

- The green LED indicates the operating voltage and the device status.
- The yellow LED lights up when the spirit level function is enabled.

The 2-axes devices have a green and two yellow LEDs.

- The green LED indicates the operating voltage and the device status.

A further description of the flashing patterns can be found in chapter Status LED [▶ 18].

3.3 Technical Data

NOTICE	Technical Data
	All technical data, as well as the mechanical and electrical characteristics, are specified in the data sheets of the corresponding device variant, for special versions in the corresponding quotation / customer drawing of the product.
NOTICE	Observe the configuration
	The performance characteristics and the mechanical design of the product depend on the selected configuration (according to order code).

3.3.1 General

EMC - Electromagnetic Compatibility

Relevant standards	EN 61326-2-3:2013
--------------------	-------------------

UL - Underwriters Laboratories

UL approval	File no. E539414
Relevant standards	UL 61010-1
	Indoor use, outdoor use possible, not designed for direct UV radiation.
Maximum air humidity	93 %, 40°C [104°F]
Environment	Dry / Wet

3.3.2 Product conformity

The product meets the following criteria:

- UL approval for the North American economic area.
- Compliance with the European Directives:
 - EMC: Directive 2014/30/EU
 - RoHS: Directive 2011/65/EU

The declaration of conformity and all certificates relating to the product can be found on the homepage.



www.kuebler.com/de/docu-finder

4 Installation

4.1 Mechanical Installation

ATTENTION	<p>Damage to the device due to transport or storage</p> <p>Device failure, malfunction, device lifetime reduction.</p> <ul style="list-style-type: none"> • Check the packaging and the device for possible damages. • In the event of visible damages, do not use the device and do not put it into operation. • Do not install the device after falling or being dropped. • Send damaged encoders back to the manufacturer with a completed return form (RMA).
------------------	---

4.1.1 General Information for the Mounting of Inclinometers

NOTICE	<p>Do not disassemble or open the inclinometer</p> <p>Inclinometer function may be lost partly or entirely.</p> <ul style="list-style-type: none"> • In no case disassemble the inclinometer entirely or partly. • Do not modify the inclinometer.
	
NOTICE	<p>Do not expose the device to impact stress.</p> <p>This would impair inclinometer accuracy and MEMS reliability.</p> <ul style="list-style-type: none"> • Do not use a hammer to align the inclinometer. • Avoid impact stress.
	

4.1.2 Mounting Instructions for Inclinometers

Depending on the sensor type, the sensors must be mounted vertically (1-axis) or horizontally (2-axes).

Depending on the application, multiple sensors can be mounted without distance from each other for a redundant measurement. Multiple sensors do not influence the angle detection among each other.

4.1.3 Cable routing

NOTICE	<p>Cable routing</p> <p>Route all lines free of any tension, so that no additional force is applied on the inclinometer . Consider the minimum bending radii of the connection line.</p> <p>Comply with the instructions in chapter Information for EMC-Compliant Installation [▶ 14].</p>
---------------	---

Wiring

When wiring the facility, pay attention to proper cable routing.

- Separate the wiring into power groups such as motor/power supply lines and signal and data lines.
- Route the signal and data lines as close as possible to ground surfaces (frames, metal rails, cabinet sides) and not parallel to motor and power supply lines or other lines carrying high interference levels.
- Do not connect other users with high interference levels (such as frequency converters, solenoid valves, contactors) to the power supply of the device.

4.1.4 Step-by-Step Installation

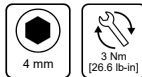
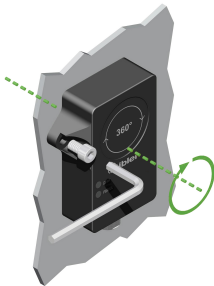

IMG-ID: 45035996610527243

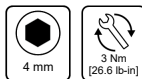
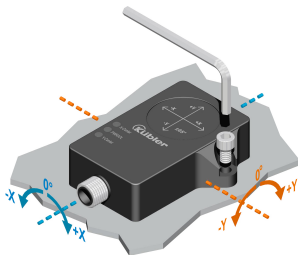

IMG-ID: 45035996610531851

- Clean the mounting surface and the mounting environment.
- Position the device with the encapsulated side on a flat surface so that the encapsulation compound is covered.

c) Fasten the device with two screws.

d) After the overhead installation of 2-axes sensors: teach the center point.

When replacing an IS40 inclinometer, Kübler offers an adapter plate with suitable drilling pattern to allow using the existing fastening holes (order code: 8.0010.4066.0000).

4.2 Electrical Installation

4.2.1 General Information for the Connection

ATTENTION	<p>Destruction of the device</p> <p>Before connecting or disconnecting the signal cable, always disconnect the power supply and secure it against switching on again.</p>
NOTICE	<p>General safety instructions</p> <p>Make sure that the entire system is in a de-energized state during electrical installation.</p>
NOTICE	<p>Other operating instructions applicable for the installation</p> <p>To connect the device, refer to the corresponding operating and safety instructions of the external drive system / evaluation system / control.</p> <p>When assembling a mating connector, comply with the instructions attached to the connector.</p>
NOTICE	<p>No open cable wires</p> <p>Connect all required cable wires / connectors before commissioning. Insulate individually all unused ends of the output signals to avoid short-circuits.</p> <ul style="list-style-type: none"> • Electrostatic discharges at the contacts of the connector or at the line ends could damage or destroy the device. Take appropriate precautionary measures.
NOTICE	<p>Traction relief</p> <p>Always mount all lines with traction relief.</p>

4.2.2 Information for EMC-Compliant Installation

Requirements for cables

a) Use exclusively shielded twisted-pair cables to connect the device.

b) Comply with the maximum permissible connection cables length.

Shielding and Equipotential Bonding

- Apply the cable shield on a large contact area - ideally 360°. Use e. g. a shield terminal to this purpose.
- Pay attention to proper cable shield fastening.
- Preferably connect the shield on both sides with low impedance to the protective earth (PE), e.g. on the device and/or on the evaluation unit. In the event of potential differences, the shield must only be applied on one side.
- If shielding is not possible, appropriate filtering measures must be taken.
- Make sure that no short-time overvoltages can occur on the signal and power supply lines when the protective earth is connected to the shield on one side only.
- For the large-area connection of the cable shield, use the shield terminal provided to this purpose. It can easily be mounted on the top-hat rail.



IMG-ID: 9007199375147403

Order code	8.0000.4G06.0312	8.0000.4G06.0718
Material	Spring steel, galvanized	
Shield diameter	3.0 ... 12.0 mm	7.0 ... 18.0 mm

Kübler offers a wide range of connection cables in various versions and lengths, see www.kuebler.com/connection-technology.

Kübler offers various solutions for EMC-compliant installation, e.g. shield terminals for the electrical cabinet, see www.kuebler.com/accessories.

4.2.3 Connecting the Connecting Wires

ATTENTION





Destruction of the electronics

When confectioning the sensor line, always take care to ensure sufficient ESD protection.

- Before connecting the connecting wires, check the assignment of the single wires.
 - After connecting, check the proper presence of the supply voltage and the proper functioning.
- If the supply voltage is reversed, the inclinometer will not operate.

4.2.4 Sensor Terminal Assignment

Device	IN61 / IN71 1-axis					
	Signal:	+V	Out ccw	0 V	Out cw	Teach / IOL
	Pin:	1	2	3	4	5

Device	IN61 / IN71 2-axes					
	Signal:	+V	Out y	0 V	Out x	Teach / IOL
	Pin:	1	2	3	4	5

- +V : Supply voltage +V DC
 0 V : Ground GND (0 V)
 Out cw : Current/voltage output ascending clockwise
 Out ccw : Current/voltage output descending counterclockwise
 Out x : Current/voltage output X-axis
 Out y : Current/voltage output Y-axis
 Teach / IOL : Teach input

5 Commissioning and Operation

5.1 Functions and Operating Modes

5.1.1 Setting Possibilities

The inclinometers have Teach inputs, which allow setting them with an IO-Link Master (see chapter Parameterizing via a Controller [▶ 23]) or with a PC with a FDT framework (e.g. PACTware) (see chapter Parameterizing via a PC [▶ 22]).

The devices have in addition an Easy-Teach function that offers the following setting possibilities by means of a teach adapter:

- Defining a new measuring range center point.
- Teaching the measuring range start (only 1-axis devices).
- Teaching the measuring range end (only 1-axis devices).
- Resetting to factory setting

See chapter Manual Parameterizing via Easy-Teach. [▶ 20].

5.1.2 Analog Outputs

The inclinometers have two analog outputs. They can be set independently of their factory setting as current or voltage outputs. The analog signal is output proportionally to the inclination angle. In factory setting, the sensors output ascending values in clockwise direction.

The output configuration set always applies to both analog outputs. The measuring range can be set freely. The maximum values of $\pm 85^\circ$ apply for the 2-axes devices. Smaller angular ranges can be set.

Current outputs

The device outputs an analog signal at each of two outputs. In the 1-axis devices, the inclination angle is additionally output inverted at the second output. In the 2-axes devices, an axis is output by each of the outputs.

The following output configurations can be set independently of the factory setting:

- 0 ... 20 mA
- 4 ... 20 mA (factory setting)

Voltage outputs

The device outputs an analog signal at each of two outputs. In the 1-axis devices, the inclination angle is additionally output inverted at the second output. In the 2-axes devices, an axis is output by each of the outputs.

The following output configurations can be set independently of the factory setting:

- 0 ... 5 V
- 0.1 ... 4.9 V
- 0.5 ... 4.5 V
- 0 ... 10 V (factory setting)

5.1.3 Measuring axes

The measuring axis of the 1-axis inclinometers covers the angular range of 0...360°.



IMG-ID: 45035996611661579

The 2-axes inclinometers cover the angular range of $\pm 85^\circ$ on two axes in all directions. This results in a non-measurable angle of 10° per 180° . The angular ranges of $\pm 85^\circ$ are maximum values. Smaller angular ranges can be set depending on the parameterizing.





IMG-ID: 45035996611644811

5.2 Status LED

PWR/IOL LED

Display	LED	Meaning
LED off	●	No voltage
LED green	●	Device ready for operation
LED green flashing	● ●	FDT/IODD communication active

Center LED (X and Y Center LED only for 2-axes device)

Display	LED	Meaning
LED yellow		Spirit level function – Center point position reached ($\pm 0.5^\circ$)
LED yellow flashing (increasing frequency)		Spirit level function – Approaching the center point position
LED yellow flashing (decreasing frequency)		Spirit level function – Leaving the center point position

5.3 Commissioning

The device is automatically ready for operation after connecting and switching it on.

5.3.1 Commissioning Help - Spirit Level

The yellow Center LEDs are used as a spirit level when aligning the inclinometer. The two yellow LEDs light up when the position of the inclinometer is in a window of $\pm 0.5^\circ$ from the center point. The flashing frequency of the LEDs increases as the sensor approaches the center point position.

One LED flashes for the 1-axis movements. Both LEDs flash for the 2-axis movements.

The spirit level function can be disabled via the Teach input.

5.4 Parameterizing

Various functions of the inclinometer can be parameterized.

Parameter	Meaning
Spirit level	The spirit level function can be disabled or enabled.
Easy-Teach	The Easy-Teach function can be disabled or enabled with this parameter. By default, this function is enabled.
Analog output	<p>The devices can be set independently of their factory setting as current or voltage outputs.</p> <p>The following settings are possible for the current outputs:</p> <p>0 ... 20 mA 4 ... 20 mA</p> <p>The following settings are possible for the voltage outputs:</p> <p>0.1 ... 4.9 V 0.5 ... 4.5 V 0 ... 5 V 0 ... 10 V</p>
Start point	<p>The start point of the characteristic output curve can be set by angle input.</p> <p>For 2-axes devices, this function allows setting another measuring range than that defined by the factory setting.</p>
End point	<p>The end point of the characteristic output curve can be set by angle input.</p> <p>For 2-axes devices, this function allows setting another measuring range than that defined by the factory setting.</p>
Defining the center point	The function allows setting the current inclination as the new measuring range center point. For 2-axes devices, the taught measuring range center point may not deviate from the physical zero point by more than 30°.
Defining the start point	The current inclination angle can be set as the start point of the characteristic output curve.
Defining the end point	The current inclination angle can be set as the end point of the characteristic output curve.
Filter	<p>Various filters can be set for the static and dynamic inclinometers.</p> <p>See chapter Filters [▶ 24].</p>

5.4.1 Manual Parameterizing via Easy-Teach.

NOTICE	Spirit level function disabled
	The spirit level function is disabled during the teach process.

Kübler offers an Easy-Teach adapter (2) (ordering designation: 05.TX40.1) that can be installed temporarily between the sensor (1) and the connection line to the application (4).

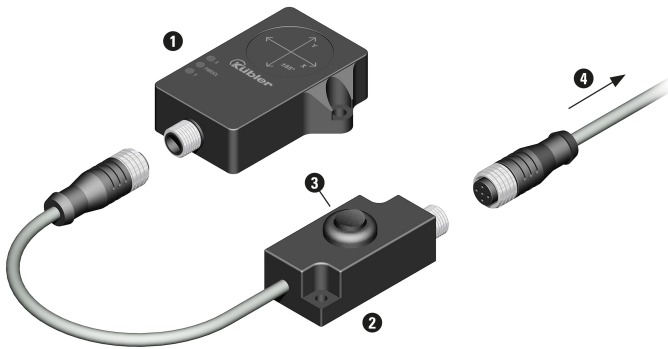

IMG-ID: 334240395

Enabling the Teach Process

- a) Keep rocker switch (3) depressed in direction "Teach-UB" (bridging pin 5 to pin 1) before switching the supply voltage on.
 - ⇒ The teach process is enabled.

As an alternative, the teach operation can also be performed manually on accessible cable wires. For this purpose, the bridging of pin 5 to pin 1 is required instead of using the Easy-Teach adapter.

! CAUTION



Caution external voltages

Make sure not to apply external voltages on the device, this could destroy the sensor.

The teach process is enabled when the PWR/IOL LED lights with short interruptions (700 ms / 100 ms).

The teach process is exited automatically after 30 s without any input. The yellow Center LED and the green PWR/IOL LED flash alternately and then go back to normal operation.

Setting the Center Point of the Measuring Range

- a) Press the rocker switch (3) during 2...8 sec. in direction "Teach-UB".
 - ⇒ The green PWR/IOL LED flashes with a frequency of 1 Hz.
- b) Position the sensor for teaching the center point.
- c) Press the rocker switch (3) during 2...8 sec. in direction "Teach-UB".
 - ⇒ The yellow Center LED flashes with a frequency of 1 Hz. The green PWR/IOL LED lights during 2 sec., then the device returns to the enabled teach process.

Setting the Start of the Measuring Range (only 1-axis devices)

- a) Press the rocker switch (3) during 2...8 sec. in direction "Teach-UB".
 - ⇒ The green PWR/IOL LED flashes with a frequency of 1 Hz.

- b) Position the sensor for teaching the start of the measuring range.
 - c) Press the rocker switch (3) during 8...14 sec. in direction "Teach-UB".
- ⇒ The yellow Center LED flashes with a frequency of 2 Hz. The green PWR/IOL LED lights during 2 sec., then the device returns to the enabled teach process.

Setting the End of the Measuring Range (only 1-axis devices)

- a) Press the rocker switch (3) during 2...8 sec. in direction "Teach-UB".
- ⇒ The green PWR/IOL LED flashes with a frequency of 1 Hz.
- b) Position the sensor for teaching the end of the measuring range.
- c) Press the rocker switch (3) during 14...20 sec. in direction "Teach-UB".
- ⇒ The yellow Center LED flashes with a frequency of 4 Hz. The green PWR/IOL LED lights during 2 sec., then the device returns to the enabled teach process.

Resetting to Factory Settings

- a) Press the rocker switch (3) during 8...14 sec. in direction "Teach-UB".
- ⇒ The green PWR/IOL LED flashes with a frequency of 2 Hz.
- b) Press the rocker switch (3) during 2...8 sec. in direction "Teach-UB".
- ⇒ The yellow Center LED flashes with a frequency of 1 Hz. The green PWR/IOL LED lights during 2 sec., then the device returns to the enabled teach process.

5.4.2 Software-Aided Parameterizing

There are two possibilities to parameterize the devices:

- by means of a PC with a FDT framework (e.g. PACTware) using the DTM or the IODD, see chapter Parameterizing via a PC [► 22].
- by means of a PLC and On-request Data Objects (e.g. near the control via an IO-Link function block), see chapter Parameterizing via a Controller [► 23].

5.4.2.1 Parameterizing via a PC

The devices can be set using a PC with an FDT framework/IODD.

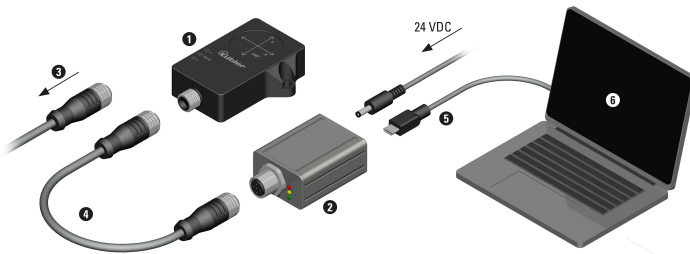

IMG-ID: 9007199588979467

Example with IO-Link Master USB

The inclinometer (1) must be disconnected from the application (3) for setting. The IO-Link Master USB (2) is connected to the inclinometer by means of the adapter cable (4) and to the PC by means of the USB interface (5).

All necessary software components can be downloaded via the Docu Finder on Kübler's website (www.kuebler.com).

- PACTware
- Device IODD
- DTM for IO-Link Master USB
- IODD DTM Configurator

The IO-Link Master USB (2) is required for connection to the PC.

- Ordering designation: 8.IO.1K1341.ZZ1UU1

An adapter cable (4) is required to connect the sensor to the IO-Link Master USB (2).

- Ordering designation: 05.00.60H1.H4H2.01M5.S004

The ports of the IO-Link Master are configured in the IOL mode.

In the IOL mode, the IO-Link Master tries to wake up the connected IO-Link device with the "Wakeup request". When the master receives a response from the IO-Link device, both devices start to communicate with each other. The communication parameters are exchanged first, then the cyclic data exchange of the process data (Process Data Objects) starts

When the IO-Link communication is active (IOL mode), an acyclic communication service is available besides the cyclic one.

5.4.2.2 Parameterizing via a Controller

The devices can be set using a controller and an IO-Link communication.

Device parameters (On-request Data Objects)

The device parameters are exchanged acyclically and on request of the IO-Link Master. The IO-Link Master always sends first a request to the device, then the device responds. This applies both to the writing of data in the device and to the reading of data from the device. The ORDO (On-request Data Objects) allow writing parameter values in the device (write) or reading device states from the device (read).

IO-Link configuration in PROFINET

SIDI (Simple IO-Link Device Integration) allows configuring IO-Link devices in PROFINET applications directly in the programming environment (e.g. TIA-Portal). The Kübler IO-Link devices are integrated in the GSDML file of the IO-Link Master and can be set in the programming environment like submodules of a modular I/O system. The user has access to all device features and parameters.

5.4.2.2.1 General parameters

Parameter	Contents
Vendor ID	408 (Fritz Kübler GmbH)
Device ID	Device-specific, see IODD
IO-Link version	1.1
Bit rate	COM3
Minimum cycle time	1.3 ms
Supports SIO	False
M-sequence capability	PREOPERATE = TYPE_1_V with 8 octet-data on request ISDU supported
Block parameters	True
Data storage	True

5.4.3 Filters

The inclinometers use an acceleration measuring cell (MEMS) to determine the angle and output this angle according to the measuring axis or axes. Due to inertia of the measuring cell in the event of fast or quickly changing rotations and of vibrations, inaccuracies may occur in the acquired measured data with respect to the actual movement. Various filters can be parameterized in the inclinometer to compensate these undesirable effects.

Parameterizing Possibility of Static Inclinometers:

- Balanced (factory setting)
- Slow

Parameterizing Possibility of Dynamic Inclinometers:

- Balanced
- Slow
- Fast
- Very fast (factory setting)

Fast Measurement

Inaccuracies due to the inertia of the test mass can be compensated for by means of filters during the acceleration measurement. However with a time lag Δt for the output of the measurement result. This time lag is reduced with the sensor fusion.

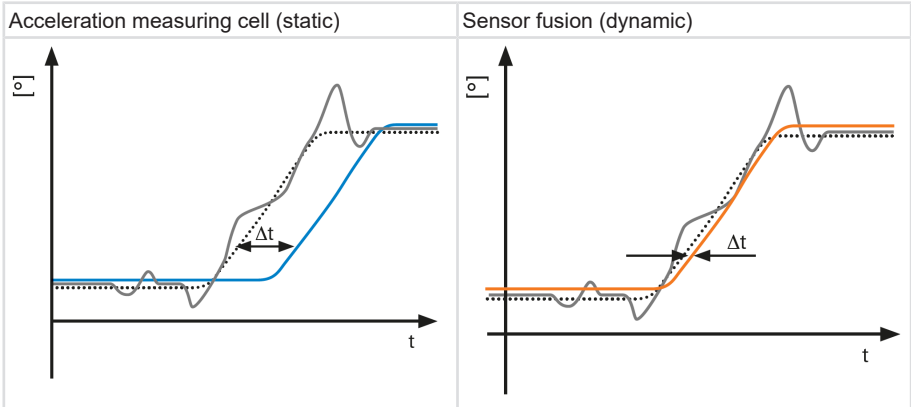

Accurate Measurement

In the event of quick direction changes, the sensor fusion leads to more accurate measurement results.

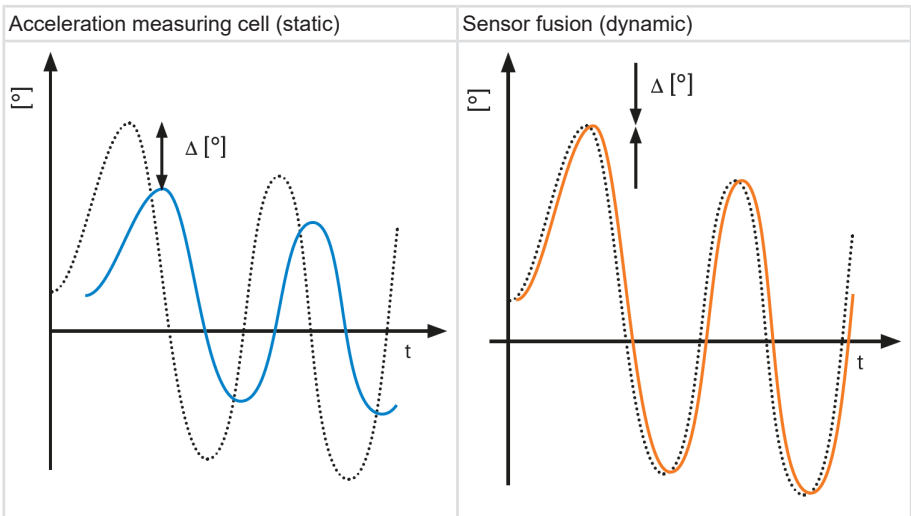

	actual movement
	data acquired by the acceleration measurement
	filtered measurement result of the acceleration measurement
	Result sensor fusion from the acceleration and rotary rate measurement

Restrictions Due to the Filters and the Sensor Fusion

Filtering always leads to a time lag Δt_q for the output of the measurement result. The more accurate the desired measurement, the larger the time lag.

The fusion algorithm integrated in the dynamic inclinometers IN7x uses the acceleration values and the rotary rate values to calculate the inclination. The setting of the filter parameters modifies important areas of the fusion algorithm. The various filters weight differently the single sensor data. The different weighting of the sensor data can compensate for disadvantages in the measurement methods.

The slow filter can compensate for fast interfering accelerations in the application. The filter suits for applications with slow and accurate movements where coarse, external interference can occur. Fast repeating movements can add up and distort the filter.

Very fast and fast filters offer higher accuracy for quick movements in the application. The filter is more easily influenced by fast interfering accelerations. Repeating movements cannot add up and distort the filter.

6 Maintenance

In harsh environments, we recommend regular inspections for firm seating and possible damages at the device. Repair or maintenance work requiring opening the device may only be performed by the manufacturer.

In the event of questions or spare parts orders, please provide us the data printed on the type plate of the device.

See chapter Contact [▶ 31].

Prior to the work

- Switch off the power supply and secure it against switching on again.
- Then disconnect the power supply lines physically.
- Remove operating and auxiliary materials and remaining processing materials from the Inclinator.

6.1 Eliminating disturbances

If the device does not operate as expected, check first whether there are ambient interferences. If there are no ambient interferences, check the device connections for errors, see chapter Sensor Terminal Assignment [▶ 16].

If there is no error, the device is probably faulty. The device must be replaced.

6.2 Disassembly

To dismantle the device, proceed in the reverse order of the assembly, see chapter Installation [▶ 12].

6.3 Reassembly

Reassembling the device is only permitted under the following conditions:

- The device is not damaged.
- The screws can be newly secured against loosening.
- All safety instructions of chapter Installation [▶ 12] can be complied with.
- All assembly steps described in chapter Installation [▶ 12] can be performed.

7 Disposal

Always dispose of unusable or irreparable devices in an environmentally sound manner, according to the country-specific provisions and in compliance with the waste disposal regulations in force. We will be glad to help you dispose of the devices.

See chapter Contact [▶ 31].

NOTICE



Environmental damage in case of incorrect disposal

Electrical waste, electronic components, lubricants and other auxiliary materials are subject to hazardous waste treatment. Problem substances may only be disposed of by licensed specialist companies.

Dispose of disassembled device components as follows:

- Metal components in the scrap metal.
- Electronic components in the electrical waste.
- Plastic parts in a recycling center.
- Sort and dispose of the other components depending on the material type.

8 Annex

8.1 Decimal / Hexadecimal conversion table

Dec	Hex	Dec	Hex	Dec	Hex	Dec	Hex	Dec	Hex
0	0x0	51	0x33	102	0x66	153	0x99	204	0xCC
1	0x1	52	0x34	103	0x67	154	0x9A	205	0xCD
2	0x2	53	0x35	104	0x68	155	0x9B	206	0xCE
3	0x3	54	0x36	105	0x69	156	0x9C	207	0xCF
4	0x4	55	0x37	106	0x6A	157	0x9D	208	0xD0
5	0x5	56	0x38	107	0x6B	158	0x9E	209	0xD1
6	0x6	57	0x39	108	0x6C	159	0x9F	210	0xD2
7	0x7	58	0x3A	109	0x6D	160	0xA0	211	0xD3
8	0x8	59	0x3B	110	0x6E	161	0xA1	212	0xD4
9	0x9	60	0x3C	111	0x6F	162	0xA2	213	0xD5
10	0xA	61	0x3D	112	0x70	163	0xA3	214	0xD6
11	0xB	62	0x3E	113	0x71	164	0xA4	215	0xD7
12	0xC	63	0x3F	114	0x72	165	0xA5	216	0xD8
13	0xD	64	0x40	115	0x73	166	0xA6	217	0xD9
14	0xE	65	0x41	116	0x74	167	0xA7	218	0xDA
15	0xF	66	0x42	117	0x75	168	0xA8	219	0xDB
16	0x10	67	0x43	118	0x76	169	0xA9	220	0xDC
17	0x11	68	0x44	119	0x77	170	0xAA	221	0xDD
18	0x12	69	0x45	120	0x78	171	0xAB	222	0xDE
19	0x13	70	0x46	121	0x79	172	0xAC	223	0xDF
20	0x14	71	0x47	122	0x7A	173	0xAD	224	0xE0
21	0x15	72	0x48	123	0x7B	174	0xAE	225	0xE1
22	0x16	73	0x49	124	0x7C	175	0xAF	226	0xE2
23	0x17	74	0x4A	125	0x7D	176	0xB0	227	0xE3
24	0x18	75	0x4B	126	0x7E	177	0xB1	228	0xE4
25	0x19	76	0x4C	127	0x7F	178	0xB2	229	0xE5
26	0x1A	77	0x4D	128	0x80	179	0xB3	230	0xE6
27	0x1B	78	0x4E	129	0x81	180	0xB4	231	0xE7
28	0x1C	79	0x4F	130	0x82	181	0xB5	232	0xE8
29	0x1D	80	0x50	131	0x83	182	0xB6	233	0xE9
30	0x1E	81	0x51	132	0x84	183	0xB7	234	0xEA

Dec	Hex	Dec	Hex	Dec	Hex	Dec	Hex	Dec	Hex
31	0x1F	82	0x52	133	0x85	184	0xB8	235	0xEB
32	0x20	83	0x53	134	0x86	185	0xB9	236	0xEC
33	0x21	84	0x54	135	0x87	186	0xBA	237	0xED
34	0x22	85	0x55	136	0x88	187	0xBB	238	0xEE
35	0x23	86	0x56	137	0x89	188	0xBC	239	0xEF
36	0x24	87	0x57	138	0x8A	189	0xBD	240	0xF0
37	0x25	88	0x58	139	0x8B	190	0xBE	241	0xF1
38	0x26	89	0x59	140	0x8C	191	0xBF	242	0xF2
39	0x27	90	0x5A	141	0x8D	192	0xC0	243	0xF3
40	0x28	91	0x5B	142	0x8E	193	0xC1	244	0xF4
41	0x29	92	0x5C	143	0x8F	194	0xC2	245	0xF5
42	0x2A	93	0x5D	144	0x90	195	0xC3	246	0xF6
43	0x2B	94	0x5E	145	0x91	196	0xC4	247	0xF7
44	0x2C	95	0x5F	146	0x92	197	0xC5	248	0xF8
45	0x2D	96	0x60	147	0x93	198	0xC6	249	0xF9
46	0x2E	97	0x61	148	0x94	199	0xC7	250	0xFA
47	0x2F	98	0x62	149	0x95	200	0xC8	251	0xFB
48	0x30	99	0x63	150	0x96	201	0xC9	252	0xFC
49	0x31	100	0x64	151	0x97	202	0xCA	253	0xFD
50	0x32	101	0x65	152	0x98	203	0xCB	254	0xFE
								255	0xFF

8.2 Conversion table Data types

Data type	Figure type	Length in bits	Length in bytes
BOOL	Binary	1	-
BYTE	Binary	8	1
WORD	Binary	16	2
DWORD	Binary	32	4
LWORD	Binary	64	8
SINT	Integer	8	1
INT	Integer	16	2
DINT	Integer	32	4
UINT	Integer	32	4
LINT	Integer	64	8
REAL	Floating point number	32	4
LREAL	Floating point number	64	8

9 Contact

You want to get in touch with us:

Technical advice

For technical advice, analysis or support during installation, Kübler is directly on site with its globally active application team.

Support International (English-speaking)

+49 7720 3903 849

support@kuebler.com

Kübler Germany +49 7720 3903 849

Kübler Australia +61 3 7044 0090

Kübler China +86 10 8471 0818

Kübler France +33 3 89 53 45 45

Kübler India +91 8600 147 280

Kübler Italy +39 0 26 42 33 45

Kübler Austria +43 3322 43723 12

Kübler Poland +48 6 18 49 99 02

Kübler Turkey +90 216 999 9791

Kübler USA +1 855 583 2537

Repair service / RMA-Form

For returns, please pack the product adequately and enclose the completed "Returns Form".

www.kuebler.com/rma

Send your return, specifying the RMA-reference, to the following address.

Kübler Group Fritz Kübler GmbH

Schubertstraße 47
D-78054 Villingen-Schwenningen
Deutschland

Tel. +49 7720 3903 0

Fax +49 7720 21564

info@kuebler.com

www.kuebler.com

Glossary

BOOL

Data type. A BOOL (or Boolean) represents a truth value that may be either true or false.

DINT

Data type. An operand of the data type DINT (double integer) has a length of 32 bits and is made of two components: a sign and a numerical value in two's complement.

DTM

Device Type Manager

DWORD

Data type. A DWORD consists of two WORDs, each consisting of 2 bytes, each of them consisting of 8 bits.

EN 61326-2-3

Electrical equipment for measurement, control and laboratory use - EMC requirements - Part 2-3: Particular requirements - Test configuration, operational conditions and performance criteria for transducers with integrated or remote signal conditioning

ESD

Electro-Static-Discharge, electro-static discharges are voltage punctures generated by large potential differences, a spark. These punctures create briefly a strong electric current.

FDT

Field Device Technology, is the interface specification for the open data interchange between field devices and automation systems.

GSDML

Generic Station Description Markup Language

INT

Data type. Integer. An integer is generally made of 16 bits.

IODD

Device description file IO-Link

IP protection level

The respective IP protection level corresponds to the suitability of an electrical device for certain environmental conditions.

ISDU

Indexed Service Data Unit

LED

Light Emitting Diode. Semiconductor component that emits light.

LWORD

Data type. Long WORD consisting of two DWORDs.

MEMS

Micro-Electro-Mechanical Systems. The micro-electro-mechanical sensors can detect mechanical, magnetic or also chemical changes and convert them into electrical information. Depending on their construction they can measure pressures, movements, gas or light.

ORDO

On-request Data Objects

PACTware



PACTware is a manufacturer and field bus-independent software for simple operation and parameterizing of field devices in automation.

PE

Abbreviation: Protective Earth, cable for safety protection against electric shocks (protective earth conductor).

PLC

Programmable Logic Controller

RMA

Return Material Authorization, authorization to return material, e.g. in the case of complaints.

SIDI

Simple IO-Link Device Integration

SINT

Data type. Short integer. An operand of the data type SINT (short INT) has a length of 8 bits and is made of two components: a sign and a numerical value.

TIA-Portal

Totally Integrated Automation Portal (TIA-Portal) is a platform provided by Siemens.

UINT

Data type. An operand of the data type UINT (Unsigned INT) has a length of 16 bits and contains numerical values without sign.

UL 61010-1

Safety requirements for electrical equipment for measurement, control and laboratory use - Part 1: General requirements

WORD

Data type. A WORD includes 2 bytes, each of them including 8 bits.



Kübler Group
Fritz Kübler GmbH
Schubertstr. 47
D-78054 Villingen-Schwenningen
Germany
Phone +49 7720 3903-0
Fax +49 7720 21564
info@kuebler.com
www.kuebler.com