

Cables and connectors

Preassembled cables

M12 connection technology

With connector, 4 pin



Female connector with coupling nut, stainless steel V4A A coded, straight

PUR cable, 4 x 0.34 mm² [AWG22]

flame retardant, seawater resistant, recyclable, PWIS free, acid/alkali/oil/ozon/UV resistant, halogen/silicone free, hydrolysis proof, drag chain-adapted, torsion resistant, welding sparks resistant

Male connector with external thread, A coded, straight



Order details

Order no.

For supply voltage	Cable length	2 m [6.56']	05.00.6061.D4D2.002M
		5 m [16.40']	05.00.6061.D4D2.005M
	
		xx m	05.00.6061.D4D2.0xxM
	standard cable length (further on request)		xx = length in meters: 2, 5, 10, 15, 20, 30

Technical data

Connector	
material housing protection	stainless steel V4A / plastic IP67, IP68
Wire cross sections	4 x 0.34 mm ² [AWG22]
Working temperature range	
flexible installation	-30 °C ... +90 °C [-22 °F ... +194 °F]
fixed installation	-40 °C ... +90 °C [-40 °F ... +194 °F]
Bending radius cable min.	
flexible installation	47.0 mm [1.85"]
fixed installation	23.5 mm [0.93"]
Cable sheath	
cable diameter approx.	4.7 mm ±0.2 mm
material sheath	PUR

Dimensions in mm [inch]

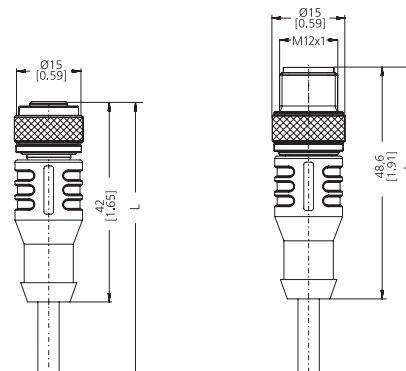

Connections

Plug-in face, A coded



Suitable for our series

Encoders singleturn	Encoders multiturn	Draw-wire encoders	Inclinometers
M3651A(R) / M3671A	M3661(R) / M3681	A41	IN81
M3658A / M3678A	M3668 / M3688	A50	
M5851A	M5861	B75	
M5858A	M5868	B80	
F5858 / F5878	F5868 / F5888	C60	
S5858 / S5878	S5868 / S5888	C100	
5858 / 5878	5868 / 5888	C105	
S3674	S3684	C120	
		D120	
		D125	
		D135	